

FLYBOX®



Fuel Comp
(Omnia57 family)

**Installation and User Manual, Safety
Instructions and Warning Booklet**

**This product is not TSO'd and cannot be installed into
traditional FAA Part 23 and similarly Type-Certificate Aircraft**

Document A2019FUEL COMP
Revision#1.0, 02/2019
For firmware version 1.0

SECTIONS

INTRODUCTION

IMPORTANT NOTICE AND WARNINGS

INDEX

OMNIA57 FAMILY SYSTEM OVERVIEW

MECHANICAL INSTALLATION

ELECTRICAL INSTALLATION

INSTRUMENT SETTINGS

OPERATING INSTRUCTIONS

TECHNICAL SPECIFICATIONS

WARRANTY

DISCLAIMER

Examples of different screens

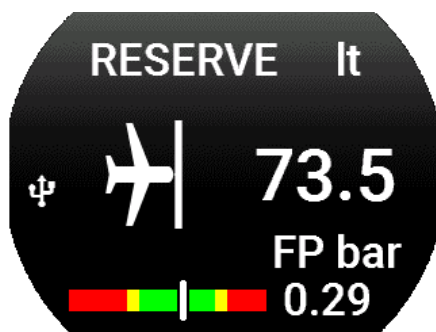
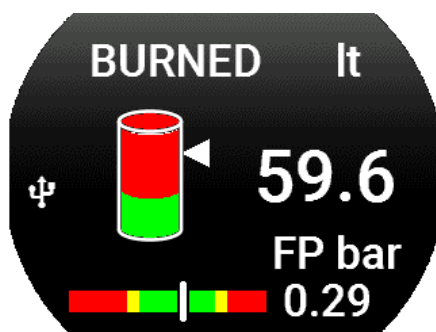
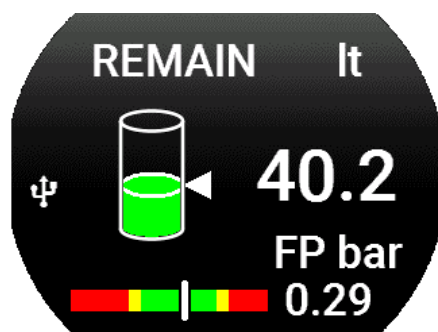
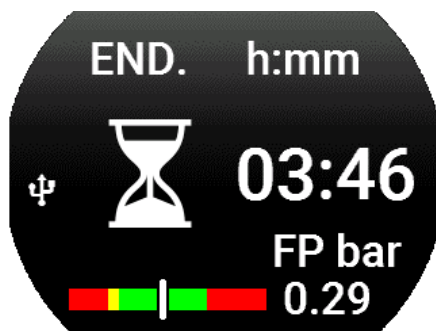
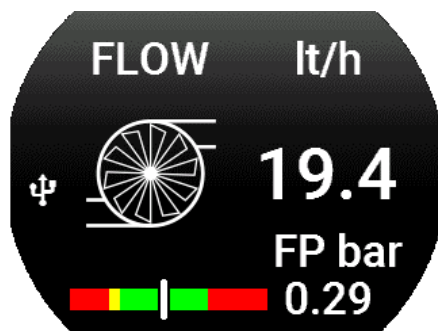

Thank you for purchasing a Flybox® **Omnia57** instrument.

Our intent in developing the **Omnia57** instrument family was to create a light and compact product, powerful and easy to install and use.

The **Omnia57** instrument family is equipped with a state-of-the-art highly visible display, a powerful 32 bit microcontroller and the latest generation of solid state sensors to ensure reliability and accuracy over time.

The owner has the possibility to keep the instrument software up-to-date by downloading the latest available revision from the www.flyboxavionics.it website and installing it using a USB pen drive.

We are confident our products will be satisfactory and will make your flying experience a pleasant one.

Symbols used in the Installation and User Manual, Safety Instructions and Warning Booklet



NOTE: Used to highlight important information.



CAUTION: Used to warn the user, it indicates a potentially hazardous situation or improper use of the product.



WARNING: Used to indicate a dangerous situation that can cause personal injury or death if the instruction is disregarded.



WARNING: These instructions must be provided to users before use, and retained for ready reference by the user. The user must read, understand (or have explained) and heed all instructions and warnings supplied with this product and with those products intended for use in association with it. Always keep a copy of the Installation and User Manual, Safety Instructions and Warning Booklet on the aircraft. In case of change of ownership, the Installation and User Manual, Safety Instructions and Warning Booklet must be delivered together with all of the other papers.



WARNING: Read the Installation and User Manual, Safety Instructions and Warning Booklet before installing the device on your aircraft and follow the procedure described therein.



WARNING: This device is intended to be installed on NON-TYPE CERTIFIED AIRCRAFT ONLY, as it does NOT require any air operator's certificate. Refer to your national aviation authorities to check if this device can be installed on your aircraft.



WARNING: It is the owner's responsibility to test this device before operating the aircraft and to make sure nobody is using it unless properly instructed and authorized to do so.



WARNING: Once the installation process is completed, it is extremely important to test the device before taking off to make sure it works properly. Therefore, we strongly suggest to double check all of the electronic instruments available on the aircraft and to turn them on to verify they function correctly.



WARNING: This device is operated through a software which from time to time can be updated and/or subject to change. Please, always refer to the Installation and User Manual, Safety Instructions and Warning Booklet for the last updated version of the software available at www.flyboxavionics.it



WARNING: It is the responsibility of the installer to properly install the device on the aircraft. In case of calibration, or any technical or functional customization of the device, the responsibility lies with the individual who carried out such operation.

FAILURE TO DO SO MAY RESULT IN SERIOUS INJURY
OR DEATH.



WARNING: If this product is not used correctly, or it is subjected to additions or alterations, the effectiveness of this device may be considerably reduced.



WARNING: Alterations, additions, or repairs not performed by the instrument manufacturer or by a person or organization authorized by the manufacturer shall negate any warranty.



WARNING: Do NOT rely on the Omnia57 Fuel L-P device ONLY to determine the level of the fuel available in the tanks.



WARNING: The unit isn't waterproof. Serious damage could occur if the unit is exposed to water or spray jets.



NOTE: The consumer decides of his own free will if the purchased product is suitable and safe for his need. If the consumer does not agree with the notices contained in this Installation and user Manual, Safety Instructions and Warning Booklet, do not install this instrument in his aircraft.



NOTE: Flybox Avionics reserves the right to change or improve its products as well as terms, conditions, and notices under which their products are offered without prior notice.



NOTE: The Installation and User Manual, Safety Instructions and Warning Booklet will be updated annually if needed.

All changes or updates will be published on our website www.flyboxavionics.com in the "support" section.



NOTE: Upon receipt of the instrument it is advisable to register on our website www.flyboxavionics.it in the "product registration" section.

The Registration data will be used only to send important news or information about available firmware updates or to communicate safety information about the instrument.

INDEX

SECTION 1 - Omnia57 Family System overview.....	1
1.1 - Construction Features	1
1.2 - Ergonomics.....	1
1.3 - Interconnection Ability	2
1.4 - Easy Software Update	3
1.5 - Easy Datalog Saving	3
1.6 - Interfaces	4
SECTION 2 - Mechanical installation.....	5
2.1 - Mechanical Dimensions.....	5
2.2 - Fuel Flow Sensors Installation.....	7
SECTION 3 - Electrical Installation.....	11
3.1 - Rear Panel Connections.....	11
3.2 - 22 Pole Female Connector Wiring.....	12
3.3 - 22 Pole Connector Table.....	13
3.4 - Sensors Electrical Connections.....	14
3.5 - CAN bus Connection Wiring.....	15
3.6 - CAN Bus Connector Tables.....	16
SECTION 4 - Instrument settings.....	17
4.1 - Minimum Settings Before First Use.....	17
4.2 - Panel Indicators And Commands.....	18
4.3 - Setup Menu Navigation.....	19
4.4 - Main Setup Menu... ..	20
4.4.1 - Gauges Submenu.....	22

4.5 - Fuel Computer Submenu.....	23
4.5.1 - K-Factor Calibration.....	26
4.5.2 - Fuel Pressure Submenu.....	28
4.6 - Backlight Submenu.....	32
SECTION 5 - Operating Instructions.....	35
5.1 - Firmware Upgrade.....	35
5.2 - Backup/Restore.....	38
5.3 - Use Of The Instrument.....	40
5.4 - Logger.....	47
TECHNICAL SPECIFICATIONS.....	48
CLEANING.....	48
WARRANTY.....	49
TERM OF USE AND DISCLAIMER.....	50

OMNIA57 FAMILY SYSTEM OVERVIEW

The **Omnia57** instrument family has many innovative features, common to all models as described below.

1.1 CONSTRUCTION FEATURES

Omnia57 instrument family is built from solid aluminum alloy, CNC milled and powder coated to last a long time over the years always showing a new appearance.

1.2 ERGONOMICS

- Large 2.4 inch TFT display, 320x240 Pixels, 1000 nits, antiglare surface, sunlight readable, wide temperature range.
- A high quality knob encoder with push button for easy access to all features.
- Backlight auto dimming feature with one optional sensor for all the Omnia57 installed in the panel.

1.3 INTERCONNECTION ABILITY

All the instruments of the **Omnia57** family can be connected together to form a communication network, making some data exchange operations simpler.

The software update of a **Omnia57** instrument connected in group takes place through the CAN bus communication with the instrument that has the USB pen drive connected. This means that the USB connection is made to a single instrument, and the information will be forwarded via CAN bus to or from all the others in the group.

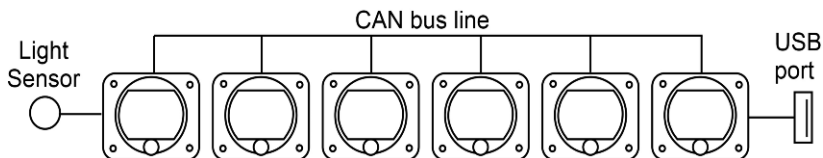

Up to 16 Omnia57 can be connected together through the CAN 1 bus.

The configuration data and the data logger of the interconnected instruments are saved or restored via CAN bus on the same USB pen drive. A single brightness sensor can provide information to all the connected instruments to automatically adjust the backlight intensity.

1.4 EASY SOFTWARE UPDATE

The user can download any new firmware, when available, from Flybox website, connect a USB pen drive to the instrument and freely update it with the last features.

With one USB connection only, it will be possible to update every instrument installed in the panel. If more Omnia57 are installed and properly connected, they will search for the right firmware through the CAN bus.

1.5 EASY DATALOG SAVING

Easy logging of the data for debug purpose. If needed, each **Omnia57** unit can save a last flight log on the USB pen drive. The user can then send the log via e-mail to Flybox support for a help/support request.

1.6 INTERFACES

All the **Omnia57** instruments have the following common interfaces:

2 separate CAN BUS: they can be used to connect the **Omnia57** instruments together, to interface them with other Flybox instruments or with external devices like Engines ECUs or new devices that will be possibly developed in the future.

2 RS232 serial ports: used to connect the **Omnia57** instruments to an external GPS (when applicable). This feature appears in some models only.

1 Sensor Light Input: if connected, it allows the automatic light intensity adjustment, one sensor for all the instruments.

2 Power outputs for sensors: one 12 V 500mA@60°C and the other 5 V 350 mA@60°C, both protected from short circuit.

If the current on one of the outputs is too high, a caution message will appear.

Caution!
High current PIN 2

1 Alarm output: all the **Omnia57** instruments can activate an external warning device like a lamp or a small relay through this NPN transistor output.

Omnia57 Fuel Comp - Installation and User Manual,
Safety Instructions and Warning Booklet

MECHANICAL INSTALLATION

2.1 MECHANICAL DIMENSIONS

The **Omnia57 Fuel Comp** instrument fits in a standard 2 ¼" (57 mm) panel cutout; it's recommended to choose a position that permits optimal display visibility. It's furnished with four M4 screws to install it to the panel, if you use other screws consider that the maximum thread length inside the instrument body is 10mm (see the picture below).

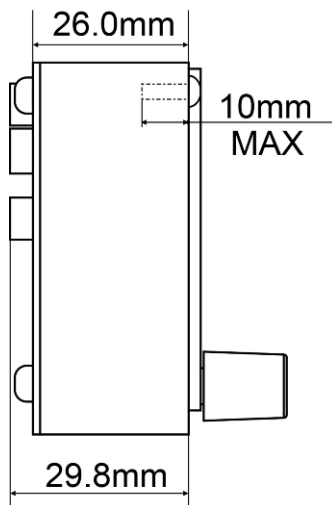

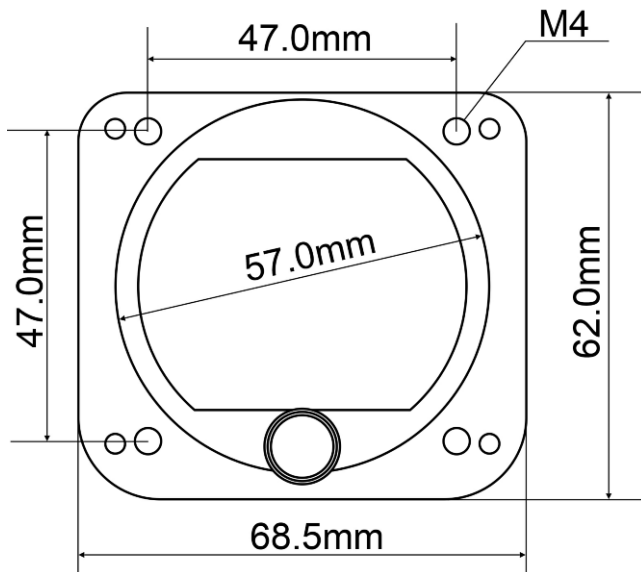

NOTE: For an installation without interference, consider making a hole of at least 57.5 mm diameter

2.2 FUEL FLOW SENSORS INSTALLATION

Omnia57 Fuel Comp has 2 fuel flow sensor inputs.

If your installation includes a flow of fuel returning to the tank, you can install the second flow meter obtaining a differential measurement.

The input 1 is dedicated to measuring fuel flowing from the tank to the engine and the input 2 is dedicated to measuring fuel returning from the engine to the tank. The flow of sensor N. 2 is subtracted from the flow measured by sensor N. 1 and the resulting amount represents the instantaneous flow of fuel burned.

Omnia57 Fuel Comp accepts all flow meters as long as they meet the characteristics listed in the technical specifications, see pag 48.

The standard one supplied from Flybox is the code 503030 EI FT-60 (RED-CUBE).

To install the fuel flow sensors, follow the manufacturer's instructions included in the sensor package, together with the general recommendations below.

- Install the sensor with the wires pointing up.
- Respect the IN and OUT port labelled on the sensor body.
- Do not install the sensor close to high temperature objects like the exhaust system or others and if needed protect the sensor with firesleeve material.
- Do not use teflon tape for the inlet and outlet ports, use liquid sealant only.
- Never clean the sensor by blowing compressed air into it.
- Install a filter in the fuel line before the sensor.
- The tubes before and after the sensor should be straight for at least 4/5 cm to avoid turbulence in the fuel and inaccurate flow data.
- Check for leakage after system starts.
- Do not clamp the sensor directly to the engine, vibrations could damage it.
- Follow the instructions supplied from the sensor manufacturer.

Example of 1 Fuel Flow Transducer for a carbureted engine.



CAUTION: your installation may be different.

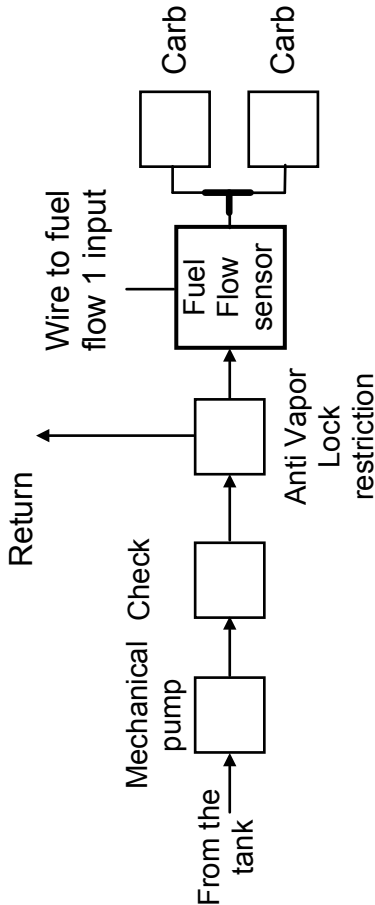

Omnia57 Fuel Comp - Installation and User Manual,
Safety Instructions and Warning Booklet

Example of 2 Fuel Flow transducers for a differential measurement.



CAUTION: your installation may be different.

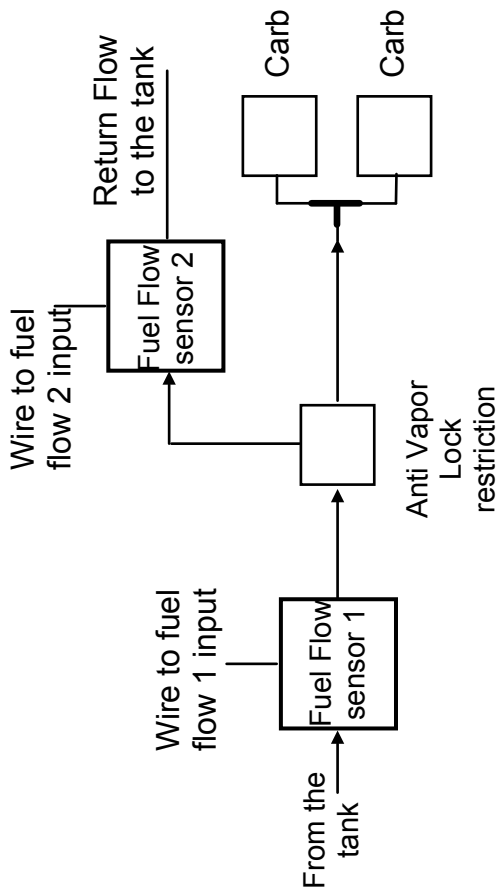

ELECTRICAL INSTALLATION

3.1 REAR PANEL CONNECTIONS

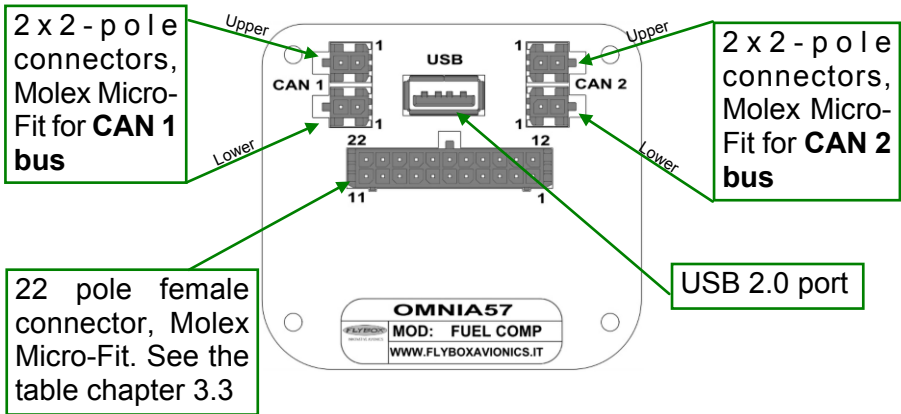

The required connectors and terminals are supplied with the instrument.

The manufacturer's codes are:

- Molex P/N 43025-0200 (2 pole housing)
- Molex P/N 43025-2200 (22 pole housing)
- Molex P/N 43030-0007 (female crimp terminal)

The terminals can be crimped with:

- Flybox Professional Crimping Tool cod. 603000
- Molex tool P/N 63819-0000

Omnia57 Fuel Comp - Installation and User Manual,
Safety Instructions and Warning Booklet

3.2 - (22 POLE) FEMALE CONNECTOR WIRING

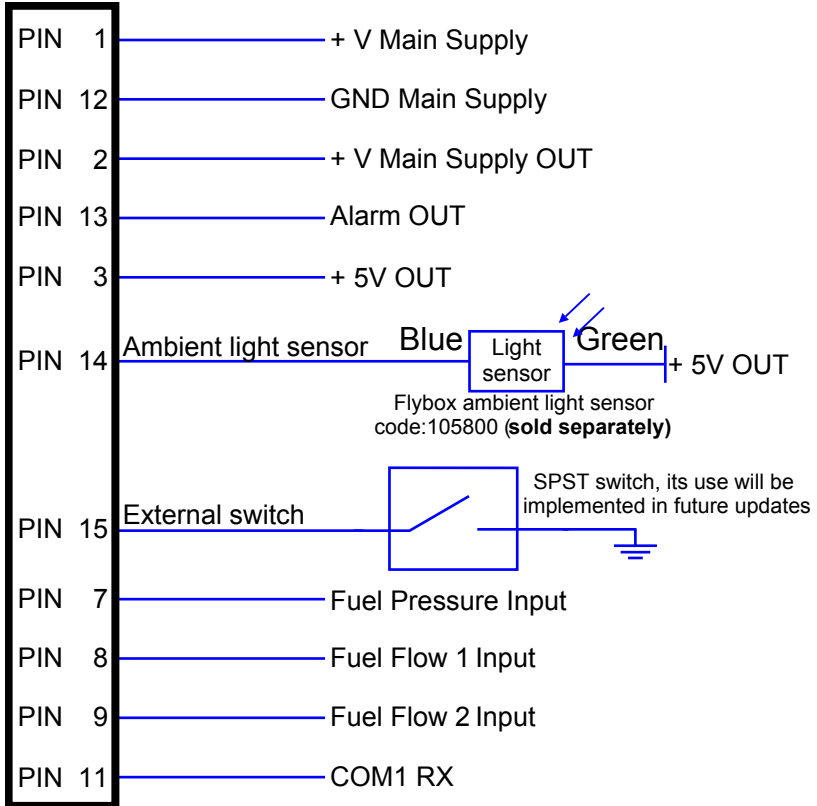

⚠ WARNING: Voltage peaks on the supply line exceeding the operating limits can damage the device.

Omnia57 Fuel Comp - Installation and User Manual,
Safety Instructions and Warning Booklet

3.3 - (22 POLE) CONNECTOR TABLE

PIN	I/O	Signal
1	I	+V Main supply, 10-30Vdc, with a proper breaker
2	O	Vout for sensors, it delivers the same voltage supplied on the Pin 1, short circuit protected and limited to 500mA
3	O	5V out for sensor, short circuit protected and limited to 350mA
7	I	Fuel Pressure input
8	I	Fuel Flow 1 Input
9	I	Fuel Flow 2 Input
11	I	COM 1 RX for GPS
12	I	GND main supply
13	O	Alarm Out, NPN 300 mA (not protected)
14	I	Ambient light sensor input
15	I	External switch

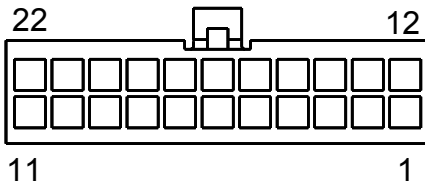

Molex P/N 43025-2200 (22 pole housing). View from wire insertion side.

3.4 SENSORS ELECTRICAL CONNECTIONS

FLYBOX Optional Fuel Pressure Sensor
Flybox code: 601040 (**sold separately**)

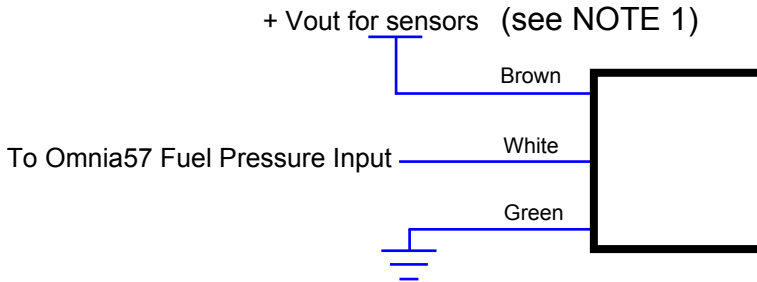

FLYBOX Optional Fuel Flow Sensor
Flybox code: 503030 (**sold separately**)

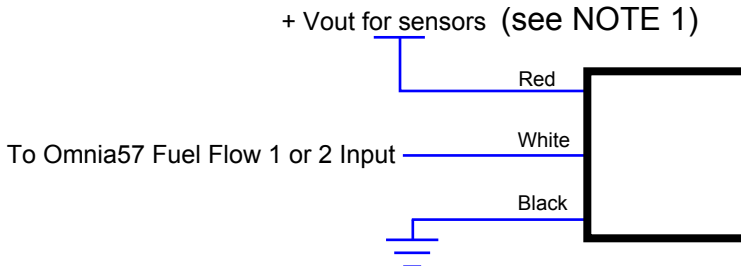

NOTE 1: use sensors which support the voltage supplied to PIN 1.

Omnia57 Fuel Comp - Installation and User Manual,
Safety Instructions and Warning Booklet

3.5 CAN BUS CONNECTION WIRING

Pin 2  Molex P/N 43025-0200 (2 pole housing). View from wire insertion side
 Pin 1

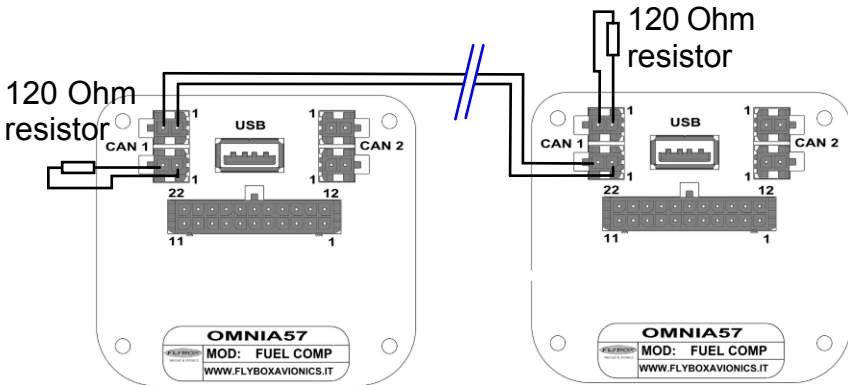

CAN bus Wiring Information

The basic electrical architecture of a CAN bus consists of a single twisted or shielded wire pair with a device connected at each end. Each end must be terminated with a 120 ohm resistor, Flybox code 105810. Up to 16 Omnia57 can be connected together through CAN 1 bus. Ready-made termination resistors and wiring for connecting several Omnia57 together are available in different lengths: 25cm, 50cm, 100cm. See the website www.flyboxavionics.it for details and how to order.

Omnia57 Fuel Comp - Installation and User Manual,
 Safety Instructions and Warning Booklet

3.6 - (2 POLE) CAN BUS CONNECTOR TABLES

PIN	I/O	Signal
1	I/O	CAN 1 H Internally connected with the Pin 1-CAN 1 H (Lower connector)
2	I/O	CAN 1 L Internally connected with the Pin 2-CAN 1 L (Lower connector)

2 Pole **CAN 1** Lower Connector

PIN	I/O	Signal
1	I/O	CAN 1 H Internally connected with the Pin 1-CAN 1 H (Upper connector)
2	I/O	CAN 1 L Internally connected with the Pin 2-CAN 1 L (Upper connector)

2 Pole **CAN 2** Upper Connector

PIN	I/O	Signal
1	I/O	CAN 2 L Internally connected with the Pin 1 CAN 2 L (Lower connector)
2	I/O	CAN 2 H Internally connected with the Pin 2 CAN 2 H (Lower connector)

2 Pole **CAN 2** Lower Connector

PIN	I/O	Signal
1	I/O	CAN 2 L Internally connected with the Pin 1 CAN 2 L (Upper connector)
2	I/O	CAN 2 H Internally connected with the Pin 2 CAN 2 H (Upper connector)

INSTRUMENT SETTINGS

4.1 MINIMUM SETTINGS BEFORE FIRST USE



CAUTION: Before using the **Omnia57 Fuel Comp** in flight for the first time, you must set at least the following parameters (as explained in the instructions on the following pages):

- Set the parameter “Eng” as explained in the chapter **4.4.1**
- Set the parameter “Space unit” as explained in the chapter **4.5**
- Set the parameter “Qty unit” as explained in the chapter **4.5**
- Set the parameter “Tank capacity” as explained in the chapter **4.5**
- If you are using the RED-CUBE FT-60 flow sensor, make sure the K factor is 68000.
- If a fuel pressure sensor is installed, set all the parameters in the “Fuel Pressure” Submenu.
- Check if the indications are correct for all the enabled gauges.



WARNING: In the absence of the above operations, or if they are not performed correctly, you can not consider as reliable the indications of the instrument.

4.2 PANEL INDICATORS AND COMMANDS

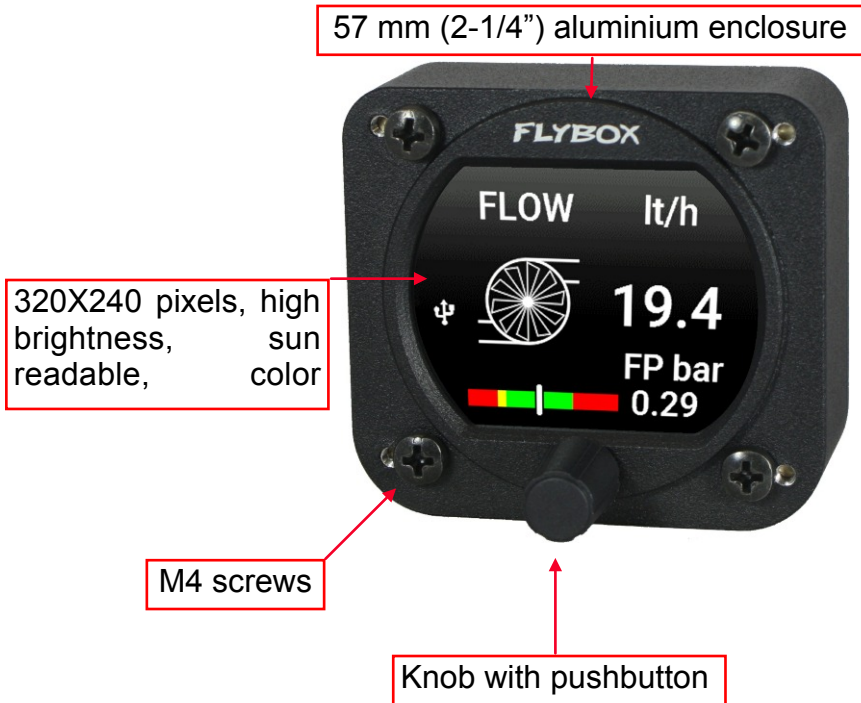

The knob can be rotated to select the functions and increment or decrement the values while pressing it to confirm.

4.3 SETUP MENU NAVIGATION

Navigation through the menus is very simple and fast using the knob:

- Press the knob for 1 second to enter in the Setup Menu. The menu automatically disappears if you don't press or rotate the knob for 5 seconds.
- Rotate the knob to navigate through menus and submenus items.
- The setup system is organized in menus and submenus; a submenu is a term used to describe a menu that is contained within another menu.
- Press the knob to enter in the selected item.
- The knob can be rotated to select the functions and increment or decrement the values while pressing it to confirm. To exit without changing while editing a number or multiple choice, keep pressed the knob for 3 seconds.
- The first items on every menu are Exit or Back. "Exit" is used to quit the Setup and go directly to the main screen, "Back" is used to go back to the previous level.

4.4 MAIN SETUP MENU

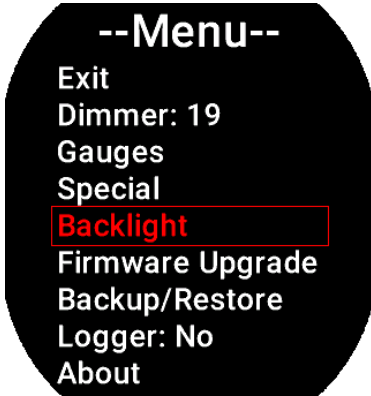

Exit: confirm to “exit” from the setup menu and go back to the main screen.

Dimmer: adjust display brightness from 1 (min brightness) to 19 (max brightness). Default value=19. The adjustment works both in Manual or in Automatic mode.

Gauges: select to enter in the “Fuel Computer” and “Fuel Pressure” gauges setup. Go to chapter 4.4.1 for a full description.

Special: enter to restore the “default settings” and the “fuel computer calculated data”.



Caution: This operations return the instrument to the factory settings. All settings will be erased. **It will require double confirmation.**

Chose “Restore default” to erase all the set parameters.

Chose “Restore FC” to set to zero endurance, burned, remaining, range and reserve calculated data. This operation can be useful for example if you change the value of the tanks capacity.

Backlight: set the backlight in “Manual” or “Automatic” mode. Go to chapter **4.6** for a full description.

Firmware Upgrade: enter to upgrade the firmware. Go to chapter **5.1** for a full description.

Backup/Restore: enter to save and load settings. Go to chapter **5.2** for a full description.

Logger: enable to save a flight session data. Go to chapter **5.4** for a full description.

About: enter to see instrument information.



About Page Example

Omnia57 Fuel Comp - Installation and User Manual,
Safety Instructions and Warning Booklet

4.4.1 Gauges Submenu

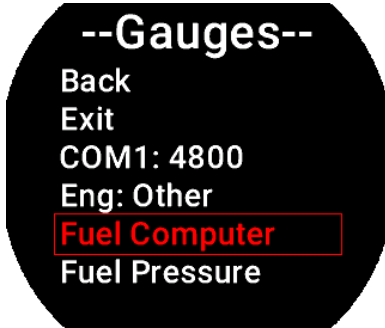

Back: confirm to go back to previous menu.

Exit: confirm to go directly to the main screen.

COM1: enter to set the baud rate of the serial RS232 port. If an external GPS is connected, the two baud rate must be the same.

ENG: choose the type of engine from: Lycoming, Continental, Rotax 912, Rotax, 914, Rotax 912iS, Rotax 915 iS. If your engine is not in the list, choose “Other”. The following table describes the source of the signals for the various gauges for each engine.

Engine	Flow Meter 1	Flow Meter 2	Fuel P
Rotax 912/914	Sensor	Sensor	Sensor
Lyc / Cont	Sensor	Sensor	Sensor
Rotax 912 iS	CAN bus	Not required	Sensor
Rotax 915 iS	CAN bus	Not required	Sensor

4.5 Fuel Computer submenu

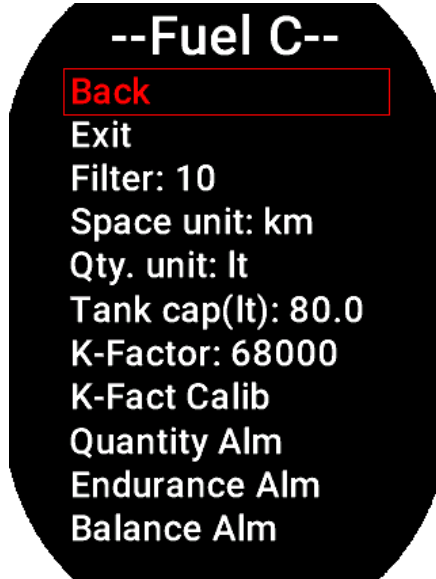

Back: go back to previous menu.

Exit: confirm to go directly to the main screen.

Filter: set the fluctuation speed of the Fuel Flow readings.

Default = 10

Min = 1 (faster)

Max = 100 (slower)

Space unit: set the unit of measure for the distance between Kilometers (km) and Nautical Miles (NM).

Q.ty unit: set the unit of measure for the fuel between Liters (lt) and U.S. Gallons (gal).

Tank cap: set the total capacity on-board as the sum of all the usable fuel in all tanks. (range 0-500lt, 0-132 gal.)

K-factor: the K-factor of a fuel flow transducer is the number of electric pulses for 1 gallon of fuel flown (if you have the K-factor in liters you must multiply this value by 3.78 before set k-factor parameter in the instrument).

If you are using the RED-CUBE FT-60 flow sensor Flybox code 503030, make sure the K factor is 68000.

If you are using another kind of Fuel Flow sensor, make sure about his compatibility of the electrical signals of amplitude and frequency and follows the manufacturer instructions to set the right K-factor in the “K-Factor” parameter.

The K-factor can be manually modified or automatically calculated with the “K-fact calib” function. It’s recommended also to execute the K-factor calibration as soon as possible to have the maximum accuracy (refer to chapter **4.5.1** “K-fact calib”).

To manually edit the K-factor select and click on the K-Factor parameter. Rotate the knob to set the first 2 digit, confirm them pushing the knob, modify the last 3 digit and confirm them pushing the knob.

K-fact calib: to increase accuracy in the fuel flow measurement you must calibrate the transducers. Go to chapter **4.5.1** for a full description.

Quantity Alm: Set the fuel quantity for the “Quantity Alm”. When the remaining quantity (REMAIN) is below this setpoint, the alarm is activated (range: 1 to max of Tank capacity, default=off). Push the knob to reset the alarm.



NOTE: Leaving this value to off, the alarm will not be activated.

Endurance Alm: Set the minimum time, in minutes, for the “Endurance Alm”. When the endurance time (END.) is below this setpoint the alarm is activated (range: 0~1000 min, default=off). Push the knob to reset the alarm.



NOTE: Leaving this value to off, the alarm will not be activated.

Balance Alm: Set the fuel quantity for the “Balance Alm”. Every time the quantity of fuel used equals this value, **Omnia57 Fuel Comp** will activate an alarm showing “TANK SWITCH” on the display. This function is useful to keep balanced two wing tanks, switching from one to the other after using a certain quantity of fuel (range: 1 to max of Tank capacity, default=off). Push the knob to reset the alarm.



NOTE: Leaving this value to off, the alarm will not be activated.

4.5.1 K-Factor Calibration



NOTE: it's recommended to perform the calibration right after installing the instrument.

1- With the aircraft in level attitude, fill the tank/s of fuel; note that in the step #4 it's required to refill the tank/s at the exact level reached here.

2- Turn-on the instrument and select "**FILLED**" when asked for the fuel quantity.

3- Burn at least 1/2 of fuel in the tank/s: a greater amount of burned fuel will increase the accuracy, and you can do this step in more flights: at the beginning of each flight you must not add fuel in the tank/s and you must select "**NO REFUEL**" when asked after turning on the instrument.

4- Fill the tank/s with the exact same level reached in the step #1, accurately measuring the quantity of fuel added in the tank/s.

5- Turn on **Omnia57 Fuel Comp** and select "**NO REFUEL**" (even though you have refilled it's required to select "**NO REFUEL**").

6- Select K-Fact Calibration, the following screen will appear:

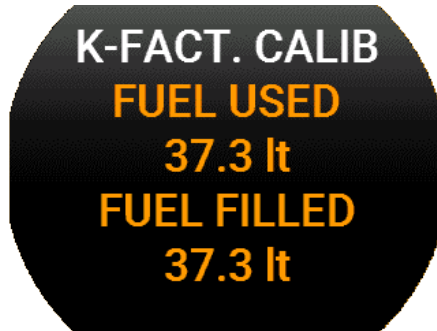

7- In the “**FUEL FILLED**” field, now insert the exact quantity of fuel you have added and measured in step #4; probably it doesn't correspond exactly to the “**FUEL USED**” because this is the measurement from the transducer not yet calibrated and it's showed for reference only. To insert the value, rotate the knob and press it to confirm. To exit without saving, press the knob for 3 seconds.

8- As soon as confirmed, the display will briefly show the newly calculated K-factor and return to the Fuel computer menu. The transducer is now calibrated and the K-factor is automatically stored in memory.

During later refuelling, it will be important to check that the fuel computer indication is correct. If the indication is very far from reality you can re-calibrate or manually change the K-factor.

4.5.2 Fuel Pressure submenu



Back: go back to previous menu.

Exit: confirm to go directly to the main screen.

Enable: set “Yes” if the Fuel Pressure sensor is installed, “No” if it isn’t installed.

Filter: set the fluctuation speed of the Fuel Pressure readings.

Default = 10

Min = 1 (faster)

Max = 100 (slower)

Unit: Select “bar” or “psi”, default is “bar”

Thresholds: set all the thresholds for the Fuel Pressure gauge.

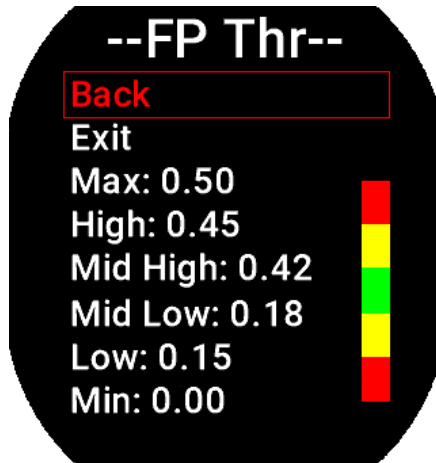

Rotate the knob to highlight the threshold you want to change, push and change the value, push again to confirm. Default thresholds are at 0.



NOTE: Start to change the maximum thresholds and then, gradually, the lower thresholds.



NOTE: To make a colored portion disappear, give the same value to the low and high thresholds of that color.

Alarms: enter to go in the Fuel Pressure Alarm menu.

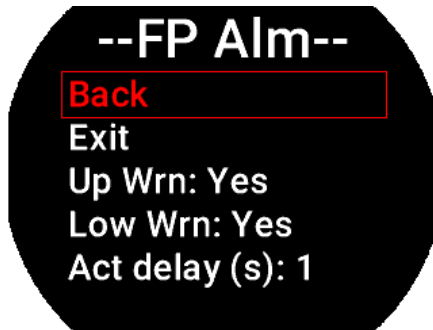

Back: go back to previous menu.

Exit: confirm to go directly to the main screen.

Up Wrn: select “Yes” to enable or select “No” to disable the High threshold alarm output.

Low Wrn: select “Yes” to enable or select “No” to disable the Low threshold alarm output.

Act delay: Select a delay in seconds before the alarm is triggered. When the Low or the High thresholds are reached, the alarm output will be activated after the set time. This option can be useful to avoid continuous alarms when the fuel pressure is stationary at values close to the set threshold.

Default = 0s

Min = 0s (faster)

Max = 10s (slower)

The alarm is only triggered if the Warning parameter is set to "Yes". The alarm event triggers both the flashing message on the screen and the alarm output. Both can be reset by pressing the knob but the rectangle behind number remains in red.

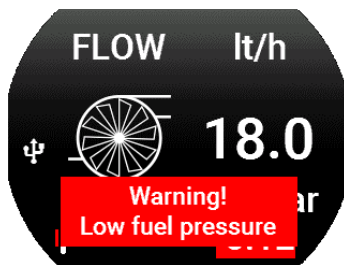

Before resetting

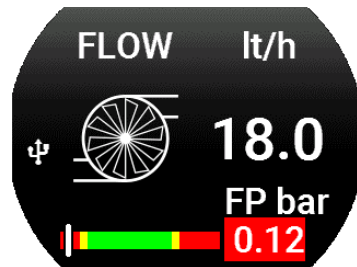

After resetting with the knob

4.6 Backlight Submenu



Back: go back to previous menu.

Exit: confirm to go directly to the main screen.

Mode: select to chose from “Manual” and “Auto”. When in “Manual” mode, the brightness can be changed with the dimmer function from the main menu, from 1 (min brightness) to 19 (max brightness). Default value=19. Selecting “Auto” new parameters will appear in the list:

Source: set how the instrument reads the ambient brightness. Choose "Sens" to read the brightness from the sensor connected to the instrument itself or "CAN" to read the ambient brightness from the CAN bus if the brightness sensor is connected to another Omnia57 instrument connected in cluster.

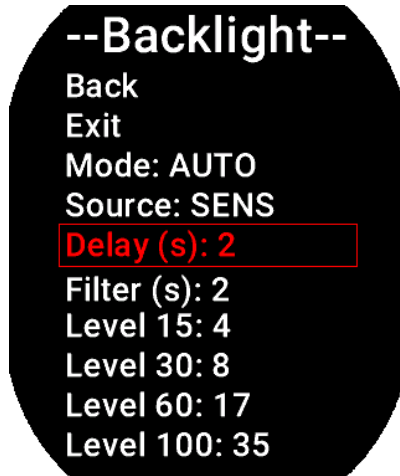

Delay (s): It introduces a delay to the variation of the backlight, it can be useful to avoid continuous changes in brightness when the sensor is hit by light and shadow alternately.

Default= 2 s
Min= 1 s (faster)
Max= 10 s (slower)

Filter (s): The filter slows down the response to changes in external brightness, it raises the value to slow down, lowers it to speed them up.

Default = 2 s
Min = 1 s (faster)
Max 30 s (slower)

This function assigns the amount of light read by the sensor to the target brightness (Level 15 = 15% brightness).

Once all 4 points have an assigned value, the brightness will change according to the amount of light read, interpolating it between the segments that are created.

Level 15: 4

Level 30: 8

Level 60: 17

Level 100: 35

Defaults values

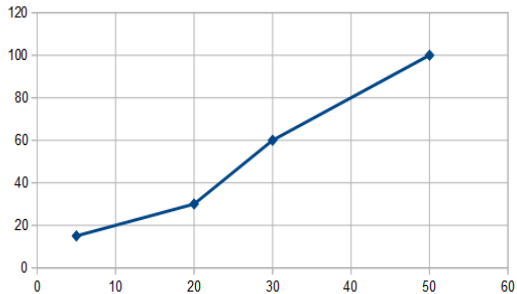

OPERATING INSTRUCTIONS

5.1 FIRMWARE UPGRADE

The **Omnia57 Fuel Comp** software can be easily updated with new versions, when available. To check if a new software version is available, see www.flyboxavionics.it under support > software page.

Download the new version and after unpacking it, copy it to a USB stick, possibly free from other files.

To update the instrument it is necessary to connect the USB stick to the instrument you want to update or to any other instrument of the Omnia57 series installed and clustered via the CAN bus, following the procedure below:

- connect the usb stick to the instrument
- From the main menu of the instrument you want to upgrade select “Firmware Upgrade”.

If the USB stick is not yet plugged-in, a message advising you to insert it will appear:



Omnia57 Fuel Comp - Installation and User Manual,
Safety Instructions and Warning Booklet

If already plugged-in, a message indicating the file and the version will appear:



Select and confirm the software you want to write, the following screen will appear:



In case you are installing a version prior to the installed one, a different message will inform that you are **downgrading** and not upgrading the software. Confirm “Yes” to proceed, “No” to exit without writing any software.

(DEV. NAME) is the name of the instrument being update.

Wait until this message will appear and then remove the USB stick. The instrument will reboot with the new software.



Note: if the USB stick is installed on a device other than the one you are updating, the following messages will appear on the 2 devices:

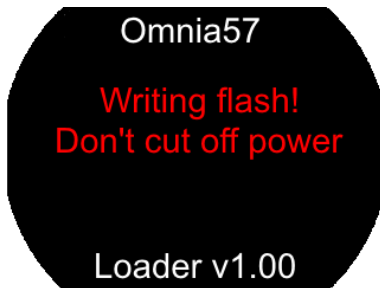

Device is being Update

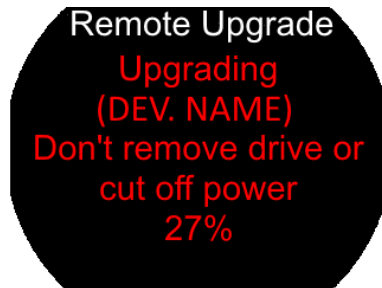

Remote device where the USB is connected

5.2 Backup / Restore

All set parameters and calibrations made in the instrument can be saved in a backup file. This can be useful if you need to restore all the parameters in a new instrument, for example in case of replacement, or if you need help from the instrument manufacturer. In this case, simply send the backup file saved on the USB stick to the Flybox support service. To backup or restore the parameters it is necessary to connect a USB stick to the instrument you want to backup/restore or to any other instrument of the Omnia57 series installed and clustered via the CAN bus.

From the main menu of the instrument you want to backup or restore the parameters, choose “Backup/Restore”. If the USB stick is not plugged-in yet , a message advising you to insert it will appear



Select “Backup” and push the knob to write the file on the USB stick. When the file is written, this message will appear:

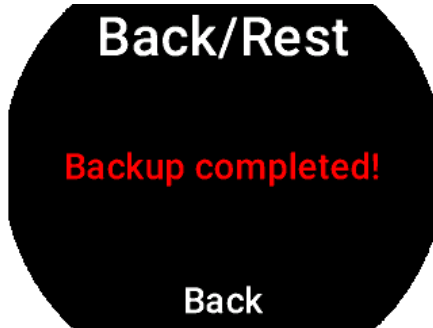

Select “Restore” and push the knob to load the previously saved parameters into the instrument.



Push the knob to reboot, the new parameters are now loaded in the instrument.

5.3 USE OF THE INSTRUMENT

When powered-on, the **Omnia57 Fuel Comp** asks if you have refuelled or not; you must choose one of the 3 available options, rotate the knob to select and press it to confirm.

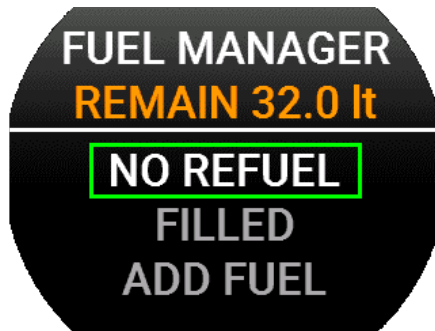

If the choice has been “NO REFUEL” or “FILLED”, the display will immediately show the Fuel Computer main page. If your choice has been “ADD FUEL”, you will be prompted to insert the fuel added quantity. Rotate the knob to the right to add a quantity and confirm pushing the knob. If you want to subtract some quantity from the existing one, turn the knob to the left. A minus symbol (-) appears before the number you are inserted, indicating that you are reducing the quantity from the “Remaining” amount.

That's the behavior of the 3 choices:

- "NO REFUEL": the "Remaining" amount of fuel will be the same as it was at the end of the previous flight.

- "FILLED": the amount of fuel will be updated to the value set in the "Total Capacity" parameter.

- "ADD FUEL": Rotate the knob to the right to add a quantity and confirm pushing the knob.

If you want to subtract a certain amount from the existing amount, turn the knob to the left. A minus symbol appears before the number you are entering, indicating that you are reducing the quantity from the "Remaining" amount.



Pressing DONE confirms the addition of 20 lt.

Pressing DONE confirms the subtraction of 5 lt.





CAUTION: Each time the fuel computer calculates the remaining amount of fuel, there will be an error due to the fact that the K-factor is not mathematically perfect. These errors, although small, will be added in the same direction and this will lead after several refueling to have an increasingly larger error. This error is reset every time you fill up with fuel, confirming the "FILLED" function. For this reason it is advisable to fill up when possible to reset the errors.



NOTE: The first time you switch-ON the **Omnia57 Fuel Comp**, the fuel pressure gauge will not be enabled, so if you have the fuel pressure sensor installed, enable it as explained in the chapter **4.5.2**.

To move between the screens of the fuel computer, turn the knob to the right and left.

The following are the various screens with explanations of their meaning.

If enabled, the fuel pressure is always shown at the bottom of all screens.

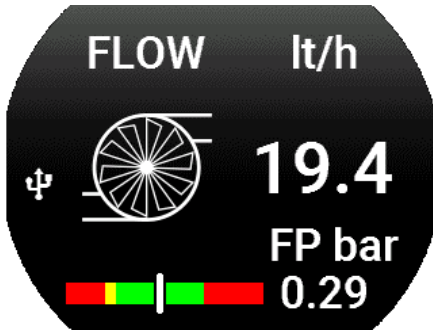

FLOW: (Fuel Flow).

According to the selected unit of measure the flow is indicated in liters per hour (Lt/h) or gallons per hour (gal/h).

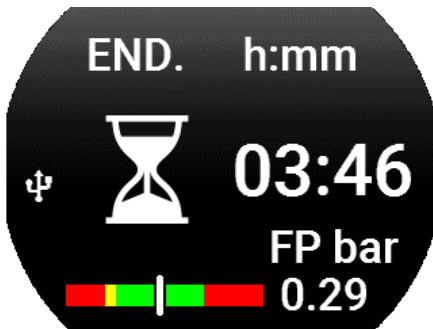

END: (Endurance).

Display the time to empty, calculated considering the fuel remaining and the actual fuel flow. If it is not possible to calculate the time to empty (for example

when the engine is not running) the display shows "--.--".

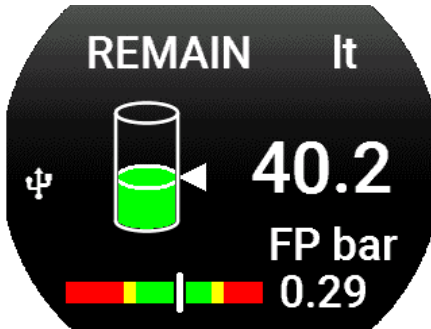

REMAIN: (Remaining Quantity). It represent the fuel remaining in the tank/s. According to the selected unit of measure the quantity is indicated in liters (Lt) or gallons (Gal).



WARNING: The remaining fuel displayed here is not a measurement of the fuel in the tank but it is calculated from the initial quantity entered by the user and the burned quantity measured by the fuel flow transducers or measured by the ECU informations.

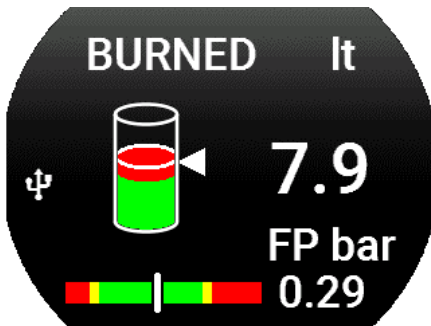

BURNED: (Fuel Burned). Display the fuel burned from the engine start. According to the selected unit of measure the flow is indicated in liters (Lt) or gallons (Gal).



RANGE: Display the range calculated considering the fuel remaining, the actual fuel flow and the ground speed furnished by the GPS.

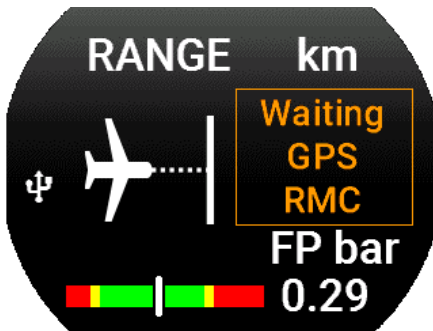

If the display shows "WAITING GPS RMC" it means that the GPS is not connected, turned off or it don't have the fix.

If it is not possible to calculate the range (for example when the engine is not running) the display shows "--:--".

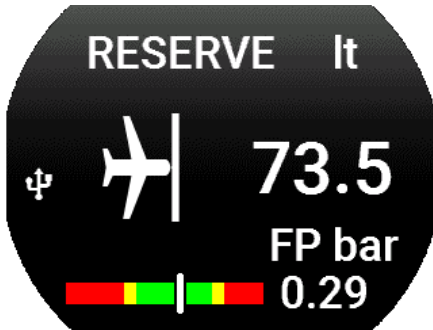

RESERVE: Display the fuel remaining at destination; the destination is intended as the approaching GPS waypoint. If the number is negative it means that there is not enough fuel to reach the destination.

To enable this indication you must connect an external GPS and enable the “RMB” sentence on it.



If the display shows “WAITING GPS RMB” it means that the GPS is not connected, turned off or it don't have the fix.

If it is not possible to calculate the reserve (for example when the engine is not running) the display shows “-.-”.

5.4 Logger

The Logger can be useful for storing flight data on the USB stick, for example to ask for assistance in case of problems.

The data will be stored at 1 second samples and written on a file with some information of the instrument that generated them.

When the USB flash drive is plugged-in to the device to be logged or to any other instrument of the Omnia57 series installed and clustered via the CAN bus, a white icon will appear on the display indicating that the flash drive is connected.

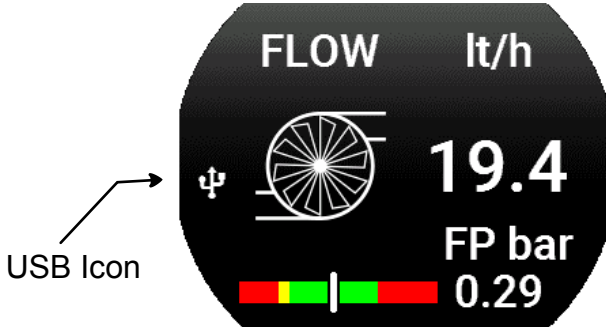

To activate the Logger choose “Yes” from the Main Menu>Logger. The icon will turn **green** when the file is being written and **red** when the Logger is enabled but the USB stick is not connected.

TECHNICAL SPECIFICATIONS

- Graphic TFT LCD with backlight and coated glass, dimensions 29x18mm.
- Standard mounting 2 1/4" (57mm).
- Powder painted aluminium case.
- Dimensions: 60 x 60 x 40 mm.
- Weight: 140g.
- 2 fuel flow sensors input with amplitude range: 5-30Vpp, frequency range 2Hz-10Khz, min. pulse duration: 50uS.
- 1 fuel pressure input 0-5V.
- Supply voltage: 10 ~ 30 V=
- GPS input: RS232 RX port
- Supply current: 60mA.
- Open-collector alarm output (max 300mA, active low). This output can also be used to send a tone in the intercom, using the Flybox optional device code 105899.
- Operating temperature range: -20 ~ +70°C.
- Humidity: 90% max (without condensation).
- Communication through 2 CAN bus.

CLEANING

The screen is very sensitive to some cleaning materials and should be cleaned with a clean, damp cloth only.

One Year Warranty:

Product support and warranty information can be found at www.flyboxavionics.it.

Flybox® warrants this Product to be free from defects in materials and workmanship for 12 months from date of delivery. The inactivity of the Products determined by periods of repair does not involve the extension of the warranty period.

This warranty covers only defects in material and workmanship found in the products under normal use and service when the product has been properly installed and maintained. This warranty does not cover failures due to abuse, misuse, accident, improper maintenance, failures to follow improper instructions or due to unauthorized alterations or repairs or use with equipments with which the Products is not intended to be used. Flybox®, after verification of the complaint and confirmation that the defect is covered by warranty, at its sole discretion, will either replace or repair the Products at no costs for the customer. Alterations, additions, or repairs not performed by the manufacturer shall negate any warranty. This warranty doesn't cover cosmetic or incidental damages. Shipping costs, taxes, custom fee, any other duties and any costs incurred while removing, reinstalling or troubleshooting the Products, shall be at customer's charge.

TO THE EXTENT PERMITTED BY LAW, THE WARRANTIES AND REMEDIES CONTAINED HEREIN ARE EXCLUSIVE AND IN LIEU OF ALL OTHER WARRANTIES EXPRESS, IMPLIED, OR STATUTORY, INCLUDING ANY LIABILITY ARISING UNDER ANY WARRANTY OF MERCHANTABILITY OR FITNESS FOR A PARTICULAR PURPOSE, STATUTORY OR OTHERWISE. THIS WARRANTY GIVES YOU SPECIFIC LEGAL RIGHTS, WHICH MAY VARY BASED ON YOUR JURISDICTION.

TO THE EXTENT PERMITTED BY LAW, IN NO EVENT SHALL UPRIGHT BE LIABLE FOR ANY INCIDENTAL, SPECIAL, INDIRECT, OR CONSEQUENTIAL DAMAGES, WHETHER RESULTING FROM THE USE, MISUSE, OR INABILITY TO USE THIS PRODUCT. SOME JURISDICTIONS DO NOT ALLOW THE EXCLUSION OF INCIDENTAL OR CONSEQUENTIAL DAMAGES, SO THE ABOVE LIMITATIONS MAY NOT APPLY TO YOU.

Out of warranty repairs

Products that can not be repaired under warranty as out of the maximum term or that do not work for reasons that would have been covered by warranty, can be repaired at a flat rate as described on the site. For out-of-warranty eligible damages, the repair must be assessed for each individual case.

Omnia57 Fuel Comp - Installation and User Manual,
Safety Instructions and Warning Booklet

Term of Use and Disclaimer

Limitation of Liability

In no event shall MICROEL s.r.l. be liable for any direct, indirect, punitive, incidental, special consequential damages whatsoever arising out of or connected with the use or misuse of its products.

Entire Obligation

The TERM OF USE, WARRANTY AND DISCLAIMER document states the entire obligation of MICROEL S.r.l. with respect to the products. If any part of this disclaimer is determined to be void, invalid, unenforceable or illegal, including, but not limited to the warranty disclaimers and liability disclaimers and liability limitations set forth above, then the invalid or unenforceable provision will be deemed superseded by a valid, enforceable provision that most closely matches the intent of the original provision and the remainder of the agreement shall remain in full force and effect.

General

This disclaimer statement is governed by the laws of ITALY. You hereby consent to the exclusive jurisdiction and venue of the Courts of competent jurisdiction, ITALY, in all disputes arising out of or relating to the use of this product. Use of this product is unauthorized in any jurisdiction that does not give effect to all provisions of these terms and conditions, including without limitation this paragraph.

Date	Revision	Description
02/2019	1.0	First release

Flybox® reserves the right to change the terms, conditions, and notices under which their products are offered without prior notice”.

WARNING: All photos, data, drawings, instruments layouts, technical solutions and data representation you find in this document or watching at FLYBOX® instruments working and/or you can access by means of any other media, including web sites, are sole property of MICROEL s.r.l., cannot be copied or imitate without a written permission of MICROEL s.r.l. itself and are protected by law, even by means of extended international copyright and/or specific patents deposited. Any infringement of this statement and of MICROEL s.r.l. intellectual property will be prosecuted.

©2019 Microel s.r.l. – all rights reserved.

Flybox® is a registered brand of Microel s.r.l.- Italy
www.flyboxavionics.it

MICROEL s.r.l.
Via Mortara 192-194
27038 Robbio (PV) - ITALY
Tel +39-0384-670602 - Fax +39-0384-671830

